

# MG Series

## Submersible Sewage & Wastewater Pumps with Grinding Mechanism

# OPERATION MANUAL

### INTRODUCTION

Thank you for selecting the Tsurumi MG Submersible Sewage & Wastewater Pumps.

This equipment should not be used for applications other than those listed in this manual. Failure to observe this precaution may lead to a malfunction or an accident. In the event of a malfunction or an accident, the manufacturer will not assume any liability. After reading this Operation Manual, keep it in a location that is easily accessible, so that it can be referred to whenever information is needed while operating the equipment.

### CONTENTS

1. BE SURE TO READ FOR SAFETY .....	1
2. PART NAMES.....	4
3. PRIOR TO OPERATION .....	4
4. INSTALLATION .....	6
5. ELECTRICAL WIRING .....	7
6. OPERATION.....	9
7. MAINTENANCE AND INSPECTION.....	11
8. DISASSEMBLY AND REASSEMBLY PROCEDURE.....	12
9. TROUBLESHOOTING .....	14

# 1 BE SURE TO READ FOR YOUR SAFETY

Be sure to thoroughly read and understand the SAFETY PRECAUTIONS given in this section before using the equipment in order to operate the equipment correctly.

The precautionary measures described in this section are intended to prevent danger or damage to you or to others. The contents of this manual that could possibly be performed improperly are classified into two categories: **⚠ WARNING**, and **⚠ CAUTION**. The categories indicate the extent of possible damage or the urgency of the precaution. Note however, that what is included under **⚠ CAUTION** may at times lead to a more serious problem. In either case, the categories pertain to safety-related items, and as such, must be observed carefully.

- **⚠ WARNING** : Operating the equipment improperly by failing to observe this precaution may possibly lead to death or injury to humans.
- **⚠ CAUTION** : Operating the equipment improperly by failing to observe this precaution may possibly cause injury to humans and other physical damage.
- **NOTE** : Gives information that does not fall in the WARNING or CAUTION categories.

## ● Explanation of Symbols:

- ⚡ : The **⚠** mark indicates a WARNING or CAUTION item. The symbol inside the mark describes the precaution in more detail ("electrical shock", in the case of the example on the left).
- ⊘ : The **⊘** mark indicates a prohibited action. The symbol inside the mark, or a notation in the vicinity of the mark describes the precaution in more detail ("disassembly prohibited", in the case of the example on the left).
- ⏚ : The **●** mark indicates an action that must be taken, or instructs how to perform a task. The symbol inside the mark describes the precaution in more detail ("provide ground work", in the case of the example on the left).

















## PRECAUTIONS TO THE PRODUCT SPECIFICATIONS

<b>⚠ CAUTION</b>	
	<p>● Do not operate the product under any conditions other than those for which it is specified. <b>Failure to observe the precaution can lead to electrical leakage, electrical shock, fire, or water leakage, etc.</b></p>



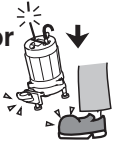

















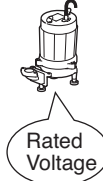





## PRECAUTIONS DURING TRANSPORT AND INSTALLATION

<b>⚠ WARNING</b>	
	<p>● When transporting the product, pay close attention to its center of gravity and mass. Use an appropriate lifting equipment to lift the unit. <b>Improper lifting may result in the product damage, injury, or death.</b></p>
	<p>● Install the product properly in accordance with this instruction manual. <b>Improper installation may result in electrical leakage, electrical shock, fire, water leakage, or injury.</b></p>
	<p>● Electrical wiring should be performed in accordance with all applicable regulations in your country. <b>Absolutely provide a dedicated earth leakage circuit breaker and a thermal overload relay suitable for the product (available on the market). Imperfect wiring or improper protective equipment can lead to electrical leakage, fire, or explosion in the worst case.</b></p>
	<p>● Provide a secure grounding dedicated for the product. Never fail to provide an earth leakage circuit breaker and a thermal overload relay in your starter or control panel (Both available on the market). <b>If an electrical leakage occurs by due to a product failure, it may cause electrical shock.</b></p>







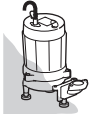







 <b>CAUTION</b>	
 <ul style="list-style-type: none"> <li>● Be sure to provide a ground wire securely. Do not connect the ground wire to a gas pipe, water pipe, lightning rod, or telephone ground wire. <b>Improper grounding could cause electrical shock.</b></li> </ul> 	 <ul style="list-style-type: none"> <li>● Do not use the cabtyre cable if it is damaged. Connect every conductor of the cabtyre cable securely to the terminals. <b>Failure to observe this can lead to electrical shock, short-circuit, or fire.</b></li> </ul> 
 <ul style="list-style-type: none"> <li>● Do not scratch, fold, twist, make alterations, or bundle the cable, or use it as a lifting device. <b>The cable may be damaged, which may cause electrical leakage, short-circuit, electrical shock, or fire.</b></li> </ul> 	 <ul style="list-style-type: none"> <li>● Provide a countermeasure against overflow, like installation of a stand-by pump. <b>If it is insufficient, the overflow may damage nearby wall, floor and other equipment.</b></li> </ul> 
 <ul style="list-style-type: none"> <li>● Install the discharge piping securely so that no water leakage may occur. <b>Failure to do so may result in damage to nearby walls, floors, and other equipment.</b></li> </ul> 	 <ul style="list-style-type: none"> <li>● When transporting the pump, pay close attention to the center of gravity and weight. <b>Imbalanced or unsteady lifting may cause falling down of the unit, which may lead to breakdown or injury.</b></li> </ul> 
 <ul style="list-style-type: none"> <li>● This pump is neither dust-proof nor explosion-proof. Do not use it at a dusty place or at a place where toxic, corrosive or explosive gas is present. <b>Use in such places could cause fire or explosion.</b></li> </ul> 	 <ul style="list-style-type: none"> <li>● If a hose is used for the discharge line, take a measure to prevent the hose from shaking. <b>If the hose shakes, you may be wet or injured.</b></li> </ul> 

## PRECAUTIONS DURING TEST OPERATION AND OPERATION





 <b>WARNING</b>	
 <ul style="list-style-type: none"> <li>● Never try to operate the pump if somebody is present in the pump sump. <b>If an electrical leakage occurs, it can cause electrical shock.</b></li> </ul> 	 <ul style="list-style-type: none"> <li>● Never start the pump while it is suspended, as <b>the unit may jerk and could lead to injury.</b></li> </ul> 
 <ul style="list-style-type: none"> <li>● When changing power connection is needed to correct the direction of rotation, be sure to turn off the power supply (earth leakage circuit breaker, etc.), and perform the work after making sure that the impeller has stopped completely. <b>Failure to do so may lead to electrical shock, short-circuit, or injury.</b></li> </ul> 	 <ul style="list-style-type: none"> <li>● When inspecting the pump, be sure to turn off the power supply (earth leakage circuit breaker, etc.) so that the pump may not start accidentally. <b>Failure to do so may lead to a serious accident.</b></li> </ul> 
 <b>CAUTION</b>	
 <ul style="list-style-type: none"> <li>● Do not operate the product under any voltage other than described on the nameplate with the voltage tolerance limit within <math>\pm 5\%</math>. If it is operated with a generator, it is strongly suggested not to operate other equipment with the same generator. <b>Failure to observe this caution may cause malfunction and breakdown of the product, which may lead to electrical leakage or electrical shock.</b></li> </ul> 	 <ul style="list-style-type: none"> <li>● Do not touch the product with bare hands during or immediate after the operation, as the product may become very hot during operation. <b>Failure to observe this caution may lead to be burned.</b></li> </ul> 
 <ul style="list-style-type: none"> <li>● Do not use the product in a liquid other than water. <b>Use in oil, salt water or organic solvents will damage it, which may lead to electrical leakage or electrical shock.</b></li> </ul> 	 <ul style="list-style-type: none"> <li>● Do not run the product dry or operate it with its valve (sluice or gate valve) closed, as <b>doing so will damage the product, which may lead to electrical leakage or electrical shock.</b></li> </ul> 

 <b>CAUTION</b>	
	<p>● Do not use the product for hot or warm liquid over 40°C, as <b>doing so will damage the product, which may lead to electrical leakage or electrical shock.</b></p> 
	<p>● Do not allow foreign objects (metal objects such as pins or wires) to enter the suction inlet of the pump. <b>Failure to observe this caution could cause it to malfunction or to operate abnormally, which may lead to electrical leakage or electrical shock.</b></p> 
	
<p>● When the product will not be used for an extended period, be sure to turn off the power supply (earth leakage circuit breaker, etc.). <b>Deterioration of the insulation may lead to electrical leakage, electrical shock, or fire.</b></p>  	





## PRECAUTIONS DURING MAINTENANCE AND INSPECTION

 <b>WARNING</b>	
	<p>● Absolutely turn off the power supply before starting maintenance or inspection. Do not work with wet hands. <b>Failure to observe these cautions may lead to electrical shock or injury.</b></p>   
	<p>● In case any abnormality (excessive vibration, unusual noise or odor) is found in the operation, turn the power off immediately and consult with the dealer where it was purchased or Tsurumi representative. <b>Continuing to operate the product under abnormal conditions may result in electrical shock, fire, or water leakage.</b></p>  
	
<p>● Do not disassemble or repair any parts other than those designated in the operation manual. If repairs are necessary in any other than the designated parts, consult with the dealer where it was purchased or Tsurumi representative. <b>Improper repairs can result in electrical leakage, electrical shock, fire, or water leakage.</b></p> 	
 <b>CAUTION</b>	
	<p>● After reassembly, always perform a test operation before resuming use of the product. <b>Improper assembly can result in electrical leakage, electrical shock, fire, or water leakage.</b></p>  

## PRECAUTION TO POWER OUTAGE

 <b>WARNING</b>	
	<p>● In case of power outage, turn off the power supply. <b>The product will resume operation when the power is restored, which presents serious danger to people in the vicinity.</b></p>  

## OTHER PRECAUTION

 <b>CAUTION</b>	
	<p>● Never use the product for potable water. <b>It may present a danger to human health.</b></p>  

## 2 PART NAMES

### Example

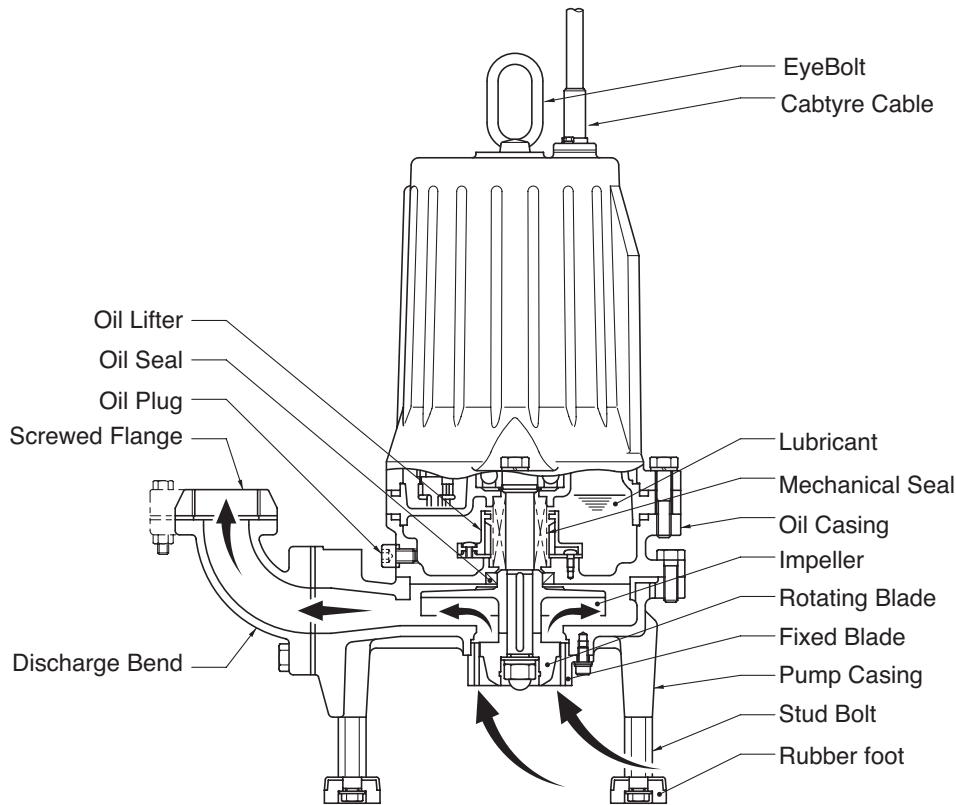

## 3 PRIOR TO OPERATION

After unpacking, verify the contents.

### Product Inspection

Inspect the product for damage during shipment, and make sure all bolts and nuts are tightened properly.

### Specification Check

Check the nameplate of the unit to verify that it is the product that you have ordered. Pay particular attention to its voltage and frequency specifications.

### Example of nameplate

<b>TSURUMI PUMP</b>		<b>SUBMERSIBLE PUMP</b> <small>(Built in motor protector)</small>	
No.	③	①	②
MODEL	④	⑤	Hz
H MAX.	⑥	m	H MIN.
⊕ Q MAX.	⑧	m <sup>3</sup> /min	DN ⑨
U	⑩	~	⑪
I			⑫
P <sub>2</sub>	⑬	kw	INS.
Wt	⑮	kg	N
	⑯	min <sup>-1</sup>	IP ⑰
	⑱	m	
<b>TSURUMI MFG.CO.,LTD.</b>			
Side View		Top View	
▲ ROTATION		⊙ ROTATION	
XXXXX			

1	Submersible pump	11	Rated voltage
2	Built in motor protector	12	Rated current
3	Serial number	13	Rated output power
4	Model	14	Insulation class
5	Frequency	15	Max. liquid temperature
6	Max. total head	16	Weight without cable
7	Min. total head	17	Speed of rotation
8	Max. flow rate	18	IP degree of protection
9	Discharge bore	19	Max. immersion depth
10	Phase	20	Direction of rotation

**Note:** If you discover any damage or discrepancy, please contact with the Tsurumi dealer from whom you purchased the product or the nearest Tsurumi representative office.

## Accessory Check

Verify that all accessory items are included in the package.

### Bend Type

- Discharge Bend (with bolts and packings) .....1 set
- Screwed Flange (with bolts and packings) .....1 set
- Operation Manual .....1

### Guide-Rail Type

- Guide Support (with bolts).....1 set
- Duck-Foot Bend (with bolts).....1 set
- Guide Hook (with bolts) .....1 set
- Chain for lifting up/down the pump (with shackle).....1 set
- Guide Connector (with bolts).....1 set
- Screwed Flange \*1 .....1 set
- Operation Manual.....1

\*1 : Some of the models are not provided.

Foundation Bolts are not provided.

**Note:** *If you discover any damage or discrepancy in the product, please contact the dealer where this equipment was purchased or the Tsurumi sales office in your area.*

## Product Specifications



### CAUTION

Do not operate this product under any conditions other than those that have been specified. Failure to observe this precaution can lead to electrical shock, electrical leakage, fire, water leakage or other problems.

### Major Standard Specifications

Fluid	Property	Waste water, sewage, and liquid carrying waste and solid matters ; 0 ~ 40°C
Pump	Impeller	Vortex type
	Shaft Seal	Double Mechanical Seal
	Bearing	Shielded Ball Bearing
Motor	Specifications	Dry type Submersible Induction Motor, 2-Pole
	Insulation	Class E , F
	Protection System (built-in)	Circle thermal protector
	Lubricant	Turbine oil VG32 (non-additive)
Discharge Connection		Special screwed flange (1.5kW max.) JIS10K flange (above 2.2kW minimum and guide-rail type)

## 4 INSTALLATION

### CAUTION

- Do not use the pump for pumping liquids other than water, such as oil, salt water, or organic solvents.
- Use with a power supply voltage tolerance within  $\pm 5\%$  of the rated voltage.
- The water temperature for operating the pump should be between  $0 \sim 40^{\circ}\text{C}$ . Failure to observe the precautions given above could cause the pump to malfunction, which may lead to current leakage or electrical shock.

**Note:** To use the pump for a special solution, contact the dealer where it was purchased, or the Tsurumi sales office in your area.

### Critical Use Pressure

### CAUTION

Do not operate the pump in an area that is exposed to a water pressure that exceeds the values given below.

Applicable Pump	Critical Use Pressure
The models with output of 2.2kW or under	0.3MPa(3kgf/cm <sup>2</sup> ) – discharge pressure during use
The models with output of 3.7kW	0.5MPa(5kgf/cm <sup>2</sup> ) – discharge pressure during use

### Preparation for Installation

#### Three-phase power supply:

Use a megger to measure the resistance between each core of the cabtyre cable and the (green) ground wire to verify the insulation resistance of the motor.

Insulation resistance reference value  
= 20M  $\Omega$  minimum

#### Three-Phase

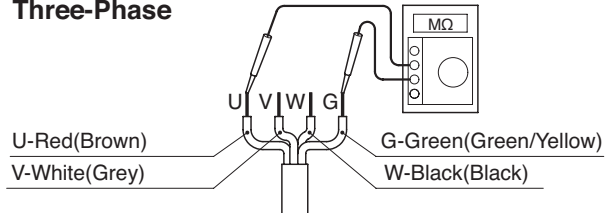

**Note:** The insulation resistance reference value of 20M  $\Omega$  minimum is based on a new or repaired pump. For reference values of a pump that has already been put into operation, refer to "7. Maintenance and Inspection" of this manual.

### Precautions During Installation

### WARNING

When installing the pump, be mindful of the pump's center of gravity and weight. If the pump is not suspended properly, the pump may fall and break, which may lead to injury.

### CAUTION

When installing or moving the pump, never suspend the pump by the cabtyre cable. Doing so will damage the cable, which may cause a current leakage, electrical shock, or fire.

Refer to the installation examples illustrated below and pay attention to the points described below to install the pump.

### CAUTION

During piping work if the welding sparks, paint, or concrete come in contact with the pump, they could cause the pump to malfunction, which may lead to current leakage or electrical shock.

#### Free Standing Specification

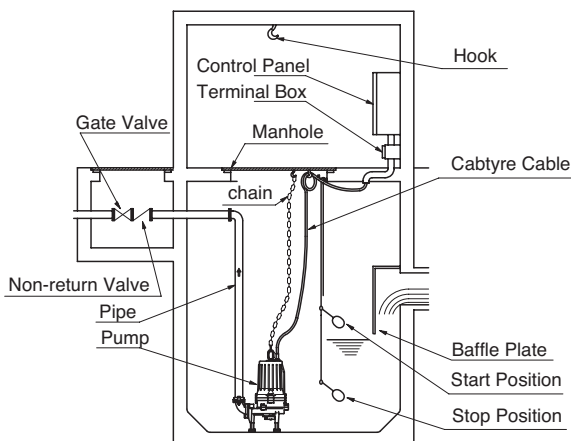

#### Guide-Rail Specification

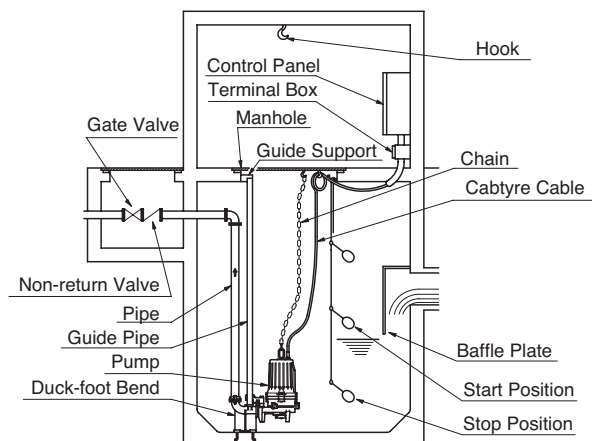

- (1) When transporting or installing the pump, do not kink the cabtyre cable or use it in place of a rope.
- (2) With the cabtyre cable lifted slightly, secure it to the hook (a hook must be prepared in advance by placing it on the frame of a manhole or the like).

**CAUTION** Do not operate the pump with the cabtyre cable dangling. Failure to observe this precaution may cause the cabtyre cable to become wrapped around the impeller, which could cut the cable, break the impeller, or cause flooding, which may lead to current leakage or electrical shock.

- (3) Install the pump horizontally on top of a surface such as concrete, in an area that is free of turbulence and does not cause the pump to take air in.
- (4) The area near the inlet of a water tank is susceptible to turbulence or allows the pump to take air in; therefore, place the pump and the float switch away from the inlet or install a baffle plate.
- (5) Properly perform piping work so as not to create any air pockets in the middle of piping.

**CAUTION** With automatic control, the sewage water in the pipe could flow backwards, causing the water surface control to react immediately. As a result, the pump will operate ON/OFF repeatedly, which could cause the pump to malfunction.

- (6) Install a non-return valve if the pump tank is deep, or if the vertical head or the lateral distance is long.

### Attaching a Chain to Suspend the Pump

Refer to the illustration on the right in order to suspend the pump by a chain.

**CAUTION** Make sure that the chain does not become twisted during installation. Failure to observe this precaution could cause the chain to break and the pump to fall and break, which could lead to injury.

When you mount shackles, be also careful so that the eye-bolt (pin) may not get dislocated, by means of providing a stainless steel wire or tying band.

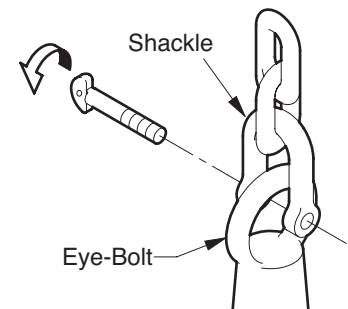

**Note:** To use the pump with the guide rail, refer to the separate operation manual entitled "Guide Rail".

## 5 ELECTRICAL WIRING

### Electrical Wiring Work

**WARNING**

- All electrical work must be performed by an authorized electrician, in compliance with local electrical equipment standards and internal wiring codes. Never allow an unauthorized person to perform electrical work because it is not only against the law, but it can also be extremely dangerous.
- Improper wiring can lead to current leakage, electrical shock, or fire.
- Absolutely provide a dedicated earth leakage circuit breaker and a thermal overload relay suitable for the pump (available on the market). Failure to follow this warning can cause electrical shock or explosion when the product fails or an electrical leakage occurs.

Operate well within the capacity of the power supply and wiring.

### Grounding

**WARNING** Be sure to install the ground wire securely. Failure to observe this precaution could damage the pump and cause current leakage, which may lead to electrical shock.

**CAUTION** Do not connect the ground wire to a gas pipe, water pipe, lightning rod, or telephone ground wire. Improper grounding could cause electrical shock.



## Connecting the Power Plug

**WARNING** Before connecting the wires to the terminal board, make sure that the power supply (i.e. circuit breaker) is properly disconnected. Failure to do so may lead to electrical shock, short, or injury caused by the unintended starting of the pump.

**CAUTION** Do not use damaged cable cables. Failure to observe this precaution could lead to electrical shock, short circuit, or fire.

Follow the diagram on the right to connect the power.

Tighten the connecting terminals at the end of the cable securely against the terminal board of the control panel.

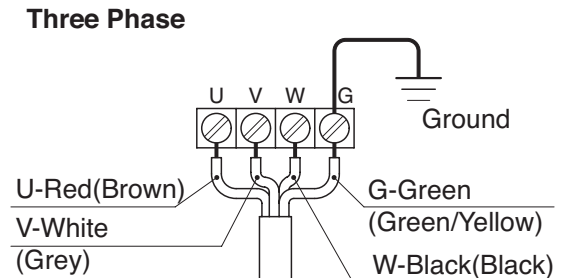

## Motor Protector

The pump is equipped with an internal motor protector.

Circle Thermal Protector:

If a current overload or overheating occurs under the symptoms given below, the pump will stop automatically to protect the motor regardless of the water level at the time of operation. Because the motor protector is designed to cancel itself automatically if it trips to stop the pump, remove the cable from the terminal board and make sure to eliminate the cause of the problem, such as the following:

- Extreme fluctuation of power supply voltage
- Pump operated under overload condition
- Pump operated at open phase or binding condition

**Note:** Make sure to eliminate the cause of the problem if the motor protector has tripped. Do not operate the pump at unusually low head, or with the impeller clogged with debris. Doing so will not only prevent the pump from attaining its full potential, but may also generate abnormal noise and vibration and damage the pump.

## Electrical Circuit Diagrams

Power Supply: Three-Phase

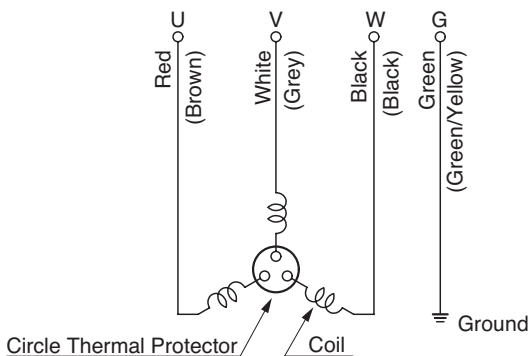

## 6 OPERATION

### Prior to Operation

(1) Once again, check the nameplate of the pump to verify that its voltage and frequency are correct.

**CAUTION** Improper voltage and frequency of the power supply will prevent the pump from attaining its full potential, and may also damage the pump.

**Note:** Verify the specs on the pump's nameplate.

(2) Check the wiring, power supply voltage, the capacity of the ground leakage circuit breaker, and the insulation resistance of the motor.

■ Insulation resistance reference value = 20MΩ minimum

**Note:** The insulation resistance reference value of 20MΩ minimum is based on a new or repaired pump. For reference values of a pump that has already been put into operation, refer to "Maintenance and Inspection".

(3) Adjust the setting of the thermal relay (i.e. 3E relay) to the pump's rated current.

**Note:** Verify the rated current on the pump's nameplate.

### Trial Operation

**WARNING** Never start the pump while it is suspended, as the pump may jerk and cause a serious accident involving injury.

(1) Operate the pump for a short time (1 to 2 seconds) and verify the direction of the rotation of the impeller. Observe the pump unit from above, and if its recoil is in the counterclockwise direction, the direction of its rotation is correct.

**CAUTION** Make sure to check the pump's direction of rotation with the pump exposed to the atmosphere. Operating the pump in reverse while it is submerged in water will damage the pump, which may lead to current leakage and electrical shock.

(2) To reverse the rotation, the following countermeasures must be taken.

**WARNING** Before changing the connections for reverse rotation, make sure that the power supply (i.e. circuit breaker) is properly disconnected and that the impeller has stopped completely. Failure to observe this may lead to electrical shock, short, or injury.

#### COUNTERMEASURE

Direct-on-line starting  
Interchange any two of the three wires designated U, V, and W, respectively.

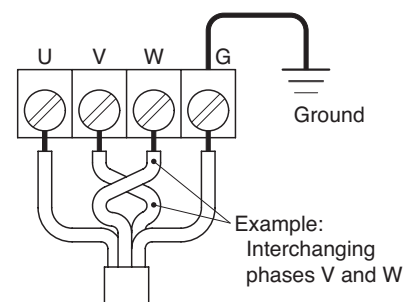

(3) Connect the pump to the pipe and submerge it in water.

(4) Operate the pump for a short time (3 to 10 minutes) and perform the following checks:

Using an AC ammeter (clamp), measure the operating current at the phases U, V, and W that are connected to the terminal board.

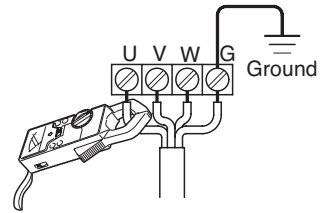

#### COUNTERMEASURE

Because an overload condition may be present at the pump motor if the operating current exceeds the rated current, follow the instructions in section "4. Installation" to operate the pump in the correct manner.

Using an AC voltmeter (tester), measure the voltage at the terminal board.

■ Power supply voltage tolerance = within  $\pm 5\%$  of the rated voltage

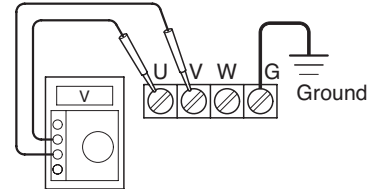

#### COUNTERMEASURE

If the power supply voltage deviates from the tolerance value, the cause of the deviation may be the capacity of the power supply or the extension cable that is used. Refer to section "5. Electrical Wiring" to operate the pump in the correct manner.

### CAUTION

**In case the pump exhibits an abnormal condition (such as a considerable amount of vibration, noise, or smell), disconnect the power supply immediately and contact the dealer where you purchased the equipment, or Tsurumi's sales office in your area. If the pump continues to be used in the abnormal state, it may cause current leakage, electrical shock, or fire.**

(5) Proceed with the normal operation if no abnormal conditions are found during the trial operation.

## Operation

### WARNING

**The pump unit may be extremely hot during operation. To prevent burns, do not touch the pump unit with bare hands during or after the operation.**

Pay attention to the water level during the pump operation. The pump will become damaged if it is allowed to operate dry.

Due to an overload operation or a pump malfunction, if the motor protector trips to stop the pump, make sure to eliminate the cause of the problem before restarting.

A frequent ON/OFF will shorten the lifetime of the pump.

To operate a submersible pump (including automatic operation), set the water level so that the pump will operate about 5 ~ 6 times per hour.

**Note:** *A large amount of amperage flows when a submersible pump is started, causing the temperature of its windings to rise rapidly. Beware that a frequent stop-and-go operation of the pump will accelerate the deterioration of the insulation of the motor windings and thus affect the use life of the motor.*

## Automatic Operation

To operate the pump in the automatic mode, a control panel is necessary for turning the pump ON/OFF by detecting the water level. The standard Tsurumi control panels include the Z type. The water level sensors that are normally used are the float switches (RF and MF types) or the level sensor (MC type); however, an electrode type may also be used.

**Note:** *Consult the operation manual provided with each equipment for its proper use.*

## Operating Water Level

### CAUTION

**Do not operate the pump at the lowest water level longer than 30 minutes, as it could damage the pump, causing current leakage and electrical shock. For details on the lowest water level, refer to the dimension drawing, which is provided separately.**



## Storage

If the pump will not be operated for a long period of time, pull the pump up, wash the pump, allow it to dry, and store it indoors.

**Note:** For reinstallation, be sure to perform a trial operation before putting the pump into operation.

If the pump remains immersed in water, operate it on a regular basis (i.e. once a week).

## Oil Inspection and Changing Procedures

### Inspecting Oil

Remove the oil plug and take out a small amount of oil. The oil can be extracted easily by tilting the pump so that the oil filler plug faces downward. If the oil appears milky or intermixed with water, a likely cause is a defective shaft sealing device (i.e. mechanical seal), which requires that the pump be disassembled and repaired.

### Changing Oil

Remove the oil plug and drain the oil completely. Pour a specified volume of oil into the oil filler inlet.

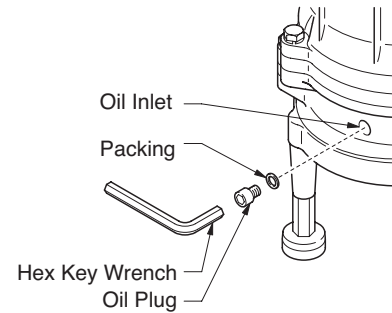

**Note:** The drained oil must be disposed of properly to prevent it from being released into the sewer or rivers. The packing or the O-ring for the oil plug must be replaced with a new part at each oil inspection and change.

Specified Oil: Turbine Oil VG32 (non-additive)  
Unit : ml

Applicable Model	Specified Volume
Model with 1.0 ~ 1.5kW power output	1,050
Model with 2.2kW power output	1,300
Model with 3.7kW power output	1,300

## 8 DISASSEMBLY AND REASSEMBLY PROCEDURE

### Prior to Disassembly and Reassembly



### WARNING

Before disassembling and reassembling the pump, be sure that the power supply (i.e. circuit breaker) is disconnected, and remove the cable from the outlet or the terminal board. Do not connect or disconnect the power plug with a wet hand, in order to prevent electrical shock. Do not perform an activation test (to check the rotation of the impeller) during disassembly and reassembly. Failure to observe this precaution could lead to a serious accident, including injury.

This section explains the disassembly and reassembly processes that are involved up to the replacement of the impeller itself. Operations involving the disassembly and reassembly of the sealing portion (i.e. mechanical seal) and of the motor require a specialized facility including vacuum and electrical test equipment. For these operations, contact the dealer where this equipment was purchased, or the Tsurumi sales office in your area.

## Disassembly Procedure

**Note:** Before disassembling, be sure to drain the Oil from the pump.

- (1) Removing the Fixed Blade  
Remove the Hex. Socket Bolts and remove the Fixed Blade from the Pump Casing.
- (2) Removing the Pump Casing  
Remove the Hex. Bolts and remove the Pump Casing and the Packing from the pump unit.
- (3) Removing the Rotating Blade and the Impeller  
Using a box wrench, remove the Impeller Nut, Spring Washer, and the Plain Washer; then, remove the Rotating Blade and the Impeller from the Shaft.



### CAUTION

A worn Impeller may have sharp edges that can cause injury, and should be handled with care.

## Disassembly Diagram

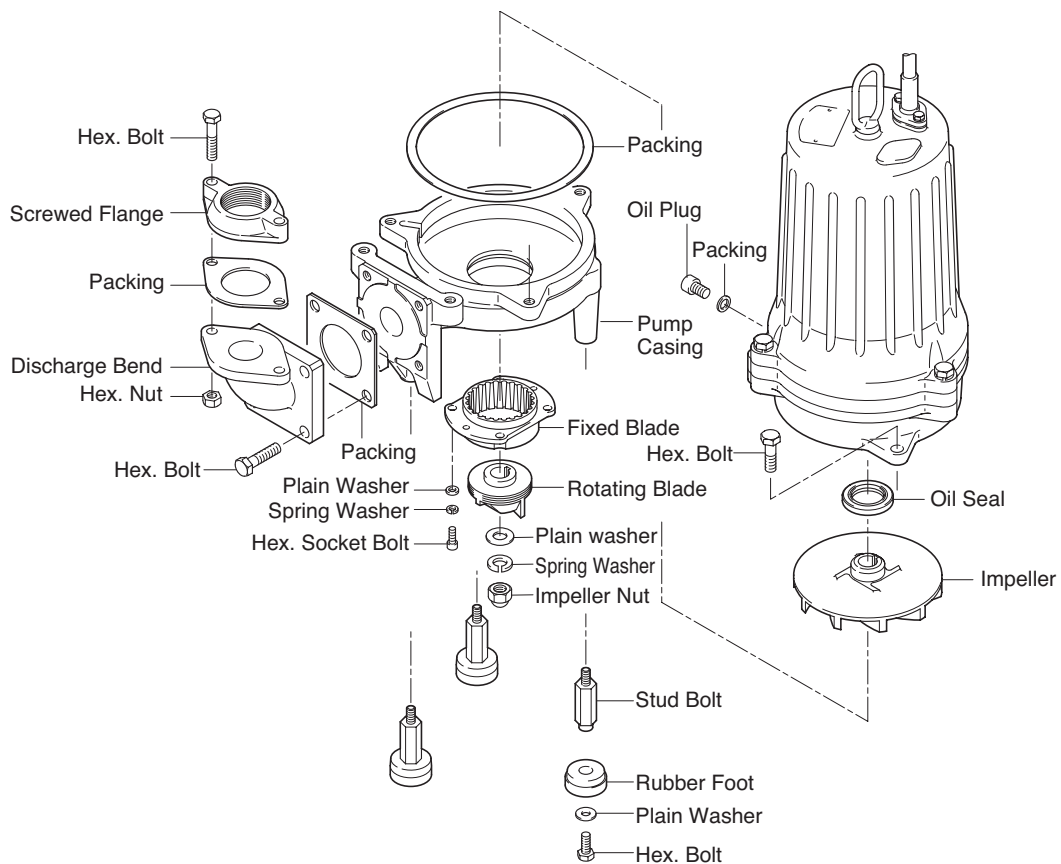

## Reassembly Procedure

Observe the precautions given below and reassemble the unit in the reverse order of disassembly.

**Note:** After completing the reassembly, make sure to fill the pump with the specified amount of oil. The packings must be replaced with a new part. If any part is worn or damaged, make sure to replace it with a new part.

After reinstalling the Fixed Blade, make sure that it does not come in contact with the Rotating Blade.

## 9 TROUBLESHOOTING

**⚠ WARNING** To prevent serious accidents, disconnect the power supply before inspecting the pump.

Read this Operation Manual carefully before requesting repair. After re-inspecting the pump, if it does not operate normally, contact the dealer where this equipment was purchased, or the Tsurumi sales office in your area.

Symptom	Cause	Countermeasure
Pump fails to start; or, starts but stops immediately.	(1)No proper power is supplied (i.e. power outage). (2)Malfunction in automatic control (control panel) (3)Foreign matter is wedged in the propeller, causing the motor protector to trip. (4)Damaged motor. (5)Open circuit or poor connection of cabtyre cable. (6)Voltage drop due to the extension of cabtyre cable.	(1>Contact the electric power company or an electrical repair shop. (2)Have the cause investigated and repaired by a specialist. (3)Inspect the pump and remove the debris. (4)Repair or replace. (5)Replace or properly connect the cabtyre cable. (6)Shorten the extension cable or replace it with one with a larger size.
Motor protector trips.	(1)Malfunction of motor (seizure or water damage). (2)A 50Hz unit is used at 60Hz. (3)Liquid temperature is too high. (4)Pump has been operating for a long time while being exposed to air. (5)Amperage overload.	(1)Repair or replace. (2)Check the nameplate and replace the pump. (3)Lower the liquid temperature. (4)Stop the pump; then lower the water level. (5)Refer to the section on amperage overload.
Pump operates but does not pump water.	(1)An air lock occurred in the pump. (2)The pump or the piping is blocked. (3)The piping is partially blocked or the valve is operating improperly. (4)The motor rotates in reverse.	(1)Stop momentarily and then restart; or, clean the air release valve. (2)Remove the blockage. (3)Remove the blockage, or repair or replace the valve. (4)Change the power supply connection.
Low pumping volume.	(1)The impeller or the pump casing is significantly worn. (2)Excessive piping loss. (3)Operating water level is too low, allowing pump to draw in air. (4)A 60Hz pump is used at 50Hz. (5)There is a leak in the piping. (6)The piping or the pump is clogged with debris.	(1)Repair or replace the affected part. (2)Re-examine the work plan. (3)Raise the water level or lower the pump position. (4)Check the nameplate and replace the pump. (5)Inspect and repair. (6)Remove the debris.
Amperage overload.	(1)Excessive imbalance in the power supply voltage. (2)Excessive voltage drop. (3)Phase interruption. (4)A 50Hz pump is used at 60Hz. (5)Motor rotates in reverse. (6)Pump is clogged with debris. (7)Motor bearing is damaged.	(1>Contact the electric power company or an electrical repair shop. (2>Contact the electric power company or an electrical repair shop. (3)Inspect the connections and the magnetic switch. (4)Check the nameplate and replace the pump. (5)Change the connection of the power wires. (6)Remove the debris. (7)Disassemble the motor and replace the bearing.
The pump does not stop automatically.	(1)The movement of the start and stop floats is obstructed. The switch in a float is faulty. (2)The water level of the stop float is set lower than the pump's minimum possible operating water level.	(1)Remove the blockage. Or, replace the part. (2)Set the water level of the stop float higher than the pump's minimum possible operating water level.
Not possible to raise the pump (Guide-rail fitting Type)	(1)Mating flange of the duckfoot bend and pump discharge flange went rusty. (2)Guide hook being seized by the guide rails. (3)Cable(s) or Chain get stuck by something.	(1)Shake the chain mildly, and lift the unit slowly. (2)loosen the chain slightly, and lift slowly while shaking it slightly. (3)Free the point that gets stuck.

The following information is required when ordering repairs or making other inquiries.

Product model	
Manufacturing number	
Purchase date	
Remarks	

### Disposal of Product

Properly dispose of the product by disassembling it, presorting the contents, and sending them to the waste material treatment site.